

VEKA-VEKB

Spare parts

Ersatzteile

Reservdelar

Varaosat



AIRTREND Ltd
Predstavništvo u Beogradu
Kumanovska 14, 11000 Beograd
Tel: 011/3836886, 3085740
Faks: 011/3444113
e-mail: gobrid@eunet.rs
web: www.airtrend.rs

FläktWoods

VEK(A,B) – Air handling unit, Luftungsgerät, Luftbehandlungsaggregat, Ilmankäsittelykone

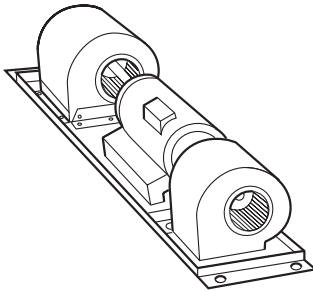
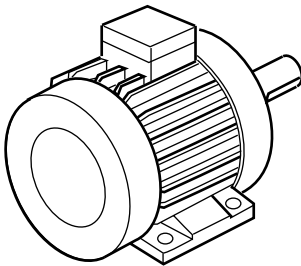
Item Teil Pos Osa	Description Beschreibung Beskrivning Kuvaus	Intended for Vorgesehen für Avsedd för Liittyy	Ordering code Bestellcode Produktkod Tilaukoodi	Remarks Bemerkung Anmärkningar Huomautus
1	Fan modul Motor-Ventilator-Einheit Fläktmodul Puhallinmoduli 	VEKA-2-bb-2-d-e-f VEKA-2-bb-3-d-e-f VEKA-2-bb-4-d-e-f VEKA-2-bb-5-d-e-f VEKA-3-bb-6-d-e-f VEKB-20-bb-4-d-e-f-g-h-i VEKB-20-bb-5-d-e-f-g-h-i VEKB-30-bb-6-d-e-f-g-h-i	VEKA-99-13-2 VEKA-99-13-3 VEKA-99-13-4 VEKA-99-13-5 VEKA-99-13-6 VEKA-99-13-4 VEKA-99-13-5 VEKA-99-13-6	
2	Motor Motor Motor Moottori 	VEKA-2-bb-2-d-e-f VEKA-2-bb-3-d-e-f VEKA-2-bb-4-d-e-f VEKA-2-bb-5-d-e-f VEKA-3-bb-6-d-e-f VEKB-20-bb-4-d-e-f-g-h-i VEKB-20-bb-5-d-e-f-g-h-i VEKB-30-bb-6-d-e-f-g-h-i	VEKA-99-14-2 VEKA-99-14-3 VEKA-99-14-4 VEKA-99-14-5 VEKA-99-14-6 VEKA-99-14-4 VEKA-99-14-5 VEKA-99-14-6	

VEK(A,B) – Air handling unit, Luftungsgerät, Luftbehandlungsaggregat, Ilmankäsittelykone

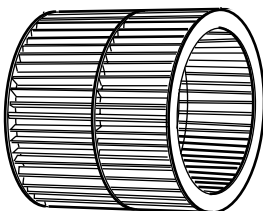
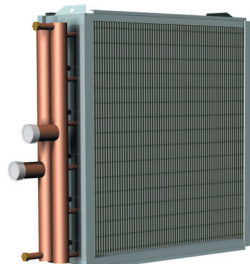
Item Teil Pos Osa	Description Beschreibung Beskrivning Kuvaus	Intended for Vorgesehen für Avsedd för Liitty	Ordering code Bestellcode Produktkod Tilaukoodi	Remarks Bemerkung Anmärkningar Huomautus
3	Impeller Laufrad Fläkthjul Siipipyörä 	VEKA-2-bb-2-d-e-f VEKA-2-bb-3-d-e-f VEKA-2-bb-4-d-e-f VEKA-2-bb-5-d-e-f VEKA-3-bb-6-d-e-f VEKB-20-bb-4-d-e-f-g-h-i VEKB-20-bb-5-d-e-f-g-h-i VEKB-30-bb-6-d-e-f-g-h-i	VEKA-99-16-1 VEKA-99-16-2 VEKA-99-16-4 VEKA-99-16-5 VEKA-99-16-3 (2x) VEKA-99-16-4 VEKA-99-16-5 VEKA-99-16-3 (2x)	
4	Heating-, cooling coil Erhitzer, Kühler Värme-, kylbatteri Lämmitys-, jäähdytys- patteri 	VEKA-2-bb-c-1-e-f VEKA-2-bb-c-2-e-f VEKA-2-bb-c-3-e-f VEKA-2-bb-c-4-e-f VEKA-2-bb-c-6-e-f VEKA-2-bb-c-7-e-f VEKA-3-bb-c-2-e-f VEKA-3-bb-c-3-e-f VEKA-3-bb-c-4-e-f VEKA-3-bb-c-6-e-f VEKA-3-bb-c-7-e-f VEKB-20-bb-c-d-2-f-g-h-i VEKB-20-bb-c-d-3-f-g-h-i VEKB-20-bb-c-d-e-4-g-h-i VEKB-30-bb-c-d-2-f-g-h-i VEKB-30-bb-c-d-3-f-g-h-i VEKB-30-bb-c-d-e-4-g-h-i	VEKE-99-02-060-030-01-20-04 VEKE-99-02-060-030-02-20-04 VEKE-99-02-060-030-03-20-04 VEKN-99-02-055-030-04-20-06 VEKN-99-02-055-030-06-20-06 VEKE-99-02-060-030-02-20-04 VEKN-99-02-055-030-04-20-06 VEKE-99-03-085-030-02-20-04 VEKE-99-03-085-030-03-20-04 VEKN-99-03-055-030-04-20-04 VEKN-99-03-055-030-06-20-04 VEKE-99-03-085-030-02-20-04 VEKN-99-03-055-030-04-20-04 VEKE-99-02-060-030-02-20-04 VEKE-99-02-060-030-03-20-04 VEKN-99-02-055-030-04-20-06 VEKE-99-03-085-030-02-20-04 VEKE-99-03-085-030-03-20-04 VEKN-99-03-085-030-04-20-06 VEKE = Heating-, Erhitzer, Värme-, Lämmitys- VEKN = Cooling, Kühler, Kyl-, Jäähdytys-.	
5	Locking handle of filter Spannvorrichtung des Filters Filtrets låsanordning Suodatinerä	VEKA-2-bb-c-d-e-f VEKA-3-bb-c-d-e-f VEKB-20-bb-c-d-e-f-g-h-i VEKB-30-bb-c-d-e-f-g-h-i	VEKA-99-15-1 VEKA-99-15-1 VEKA-99-15-1 VEKA-99-15-1	

VEK(A,B) – Air handling unit, Luftungsgerät, Luftbehandlungsaggregat, Ilmankäsittelykone

Item Teil Pos Osa	Description Beschreibung Beskrivning Kuvaus	Intended for Vorgesehen für Avsedd för Liitty	Ordering code Bestellcode Produktkod Tilaukoodi	Remarks Bemerkung Anmärkningar Huomautus		
6	Filterset Ersatzfilter, Satz Filtersats Suodatinerä	VEKA-2-bb-c-d-1-f (G3)	VEKZ-54-1	592x287x120 mm		
		VEKA-2-bb-c-d-2-f (G3)	VEKZ-54-2	592x287x360 mm		
		VEKA-2-bb-c-d-3-f (F6)	VEKZ-54-3	592x287x520 mm		
		VEKA-2-bb-c-d-4-f (F6)	VEKZ-54-4	592x287x360 mm		
		VEKA-3-bb-c-d-1-f (G3)	VEKZ-54-5	892x287x120 mm		
		VEKA-3-bb-c-d-2-f (G3)	VEKZ-54-6	892x287x360 mm		
		VEKA-3-bb-c-d-3-f (F6)	VEKZ-54-7	892x287x520 mm		
		VEKA-3-bb-c-d-4-f (F6)	VEKZ-54-8	892x287x360 mm		
		VEKB-20-bb-c-d-e-f-1-h-i (G3)	VEKZ-54-1	592x287x120 mm		
		VEKB-20-bb-c-d-e-f-2-h-i (G3)	VEKZ-54-2	592x287x360 mm		
		VEKB-20-bb-c-d-e-f-3-h-i (F6)	VEKZ-54-4	592x287x360 mm		
		VEKB-30-bb-c-d-e-f-1-h-i (G3)	VEKZ-54-5	892x287x120 mm		
		VEKB-30-bb-c-d-e-f-2-h-i (G3)	VEKZ-54-6	892x287x360 mm		
		VEKB-30-bb-c-d-e-f-3-h-i (F6)	VEKZ-54-8	892x287x360 mm		
		7	Handle Handgriff Handtag Kahva	VEKA-2-bb-c-d-e-f VEKA-3-bb-c-d-e-f	VEKA-99-18-1	Handle without lock Handgriff ohne Schloss Handtag utan lås Kahva salpaan kanssa
				VEKB-20-bb-c-d-e-f-g-h-i VEKB-30-bb-c-d-e-f-g-h-i	VEKA-99-18-2	Knob Drehknopf Vredknopp Nuppi
VEKB-20-bb-c-d-e-f-g-h-i VEKB-30-bb-c-d-e-f-g-h-i	VEKA-99-18-3			Lock Schloß Lucklås Luukun lukko		

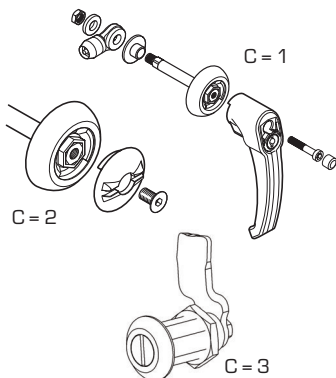
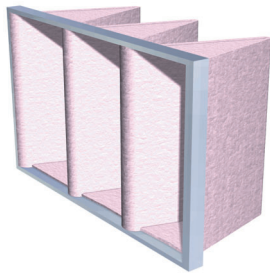

VEK(A,B) – Air handling unit, Luftungsgerät, Luftbehandlungsaggregat, Ilmankäsittelykone

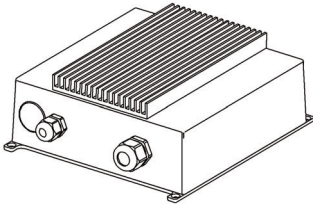
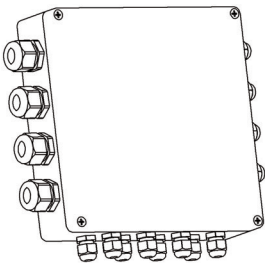
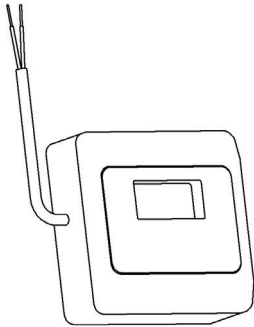
Item Teil Pos Osa	Description Beschreibung Beskrivning Kuvaus	Intended for Vorgesehen für Avsedd för Liittyy	Ordering code Bestellcode Produktkod Tilaukoodi	Remarks Bemerkung Anmärkningar Huomautus
8	Frequency inverter Frequenzumformer Frekvensomriktare Taajuusmuuttaja 	VEKB-20-bb-4-d-e-f-g-h-i (0.75kW) VEKB-20-bb-5-d-e-f-g-h-i (1.5kW) VEKB-30-bb-6-d-e-f-g-h-i (1.5kW)	STVE-99-01-1 STVE-99-02-1 STVE-99-02-1	
9	Control unit Steuereinheit Styrenhet Ohjausyksikkö 	VEKB-20-bb-c-d-e-f-g-h-i VEKB-30-bb-c-d-e-f-g-h-i	STVE-99-03-1 STVE-99-03-1	
10	Control panel Bedienungstafel Kontrollpanel Ohjaustaulu 	VEKB-20-bb-c-d-e-f-g-h-i VEKB-30-bb-c-d-e-f-g-h-i	STVE-99-04-c-1 STVE-99-04-c-1 c = 1 Svenska c = 2 Deutsch c = 3 English c = 4 Suomi	



Fläkt Woods, 551 84 Jönköping, Sweden

t +46 36 19 30 00 f +46 36 19 36 20
w www.flaktwoods.com